



fi-7600/fi-7700/fi-7700S Image Scanner

Rychlá instalace

1

[fi-7600]

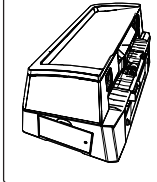

[fi-7700/fi-7700S]

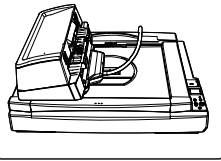

Skener



Automatický podavač ADF



Stohovač

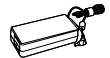

Napájecí adaptér



Napájecí kabel (*)



USB kabel



Instalační DVD-ROM

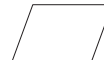

Bezpečnostní pokyny



Rychlá instalace (tento list)

(*) Obsah balení se může lišit v různých zemích a pro různé modely.

2

1

Odstraňte ochranné fólie a nálepky.

2

Nasadte stohovač a podavač ADF na skener.

[fi-7600]

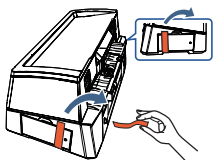

[fi-7700/fi-7700S]

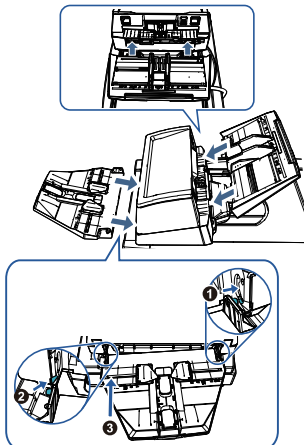
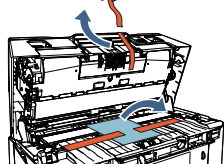
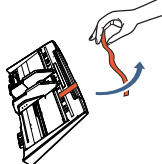
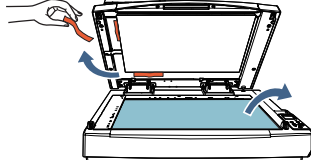

3

[fi-7600]

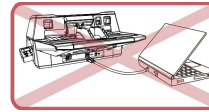

1 Instalační DVD-ROM

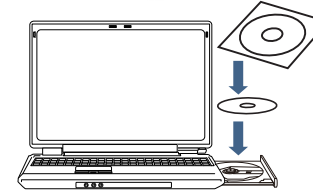

[fi-7700/fi-7700S]



2



4

[fi-7600]

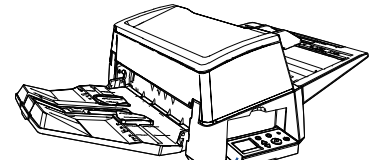
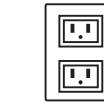
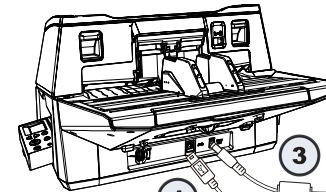

ON

[fi-7700/fi-7700S]

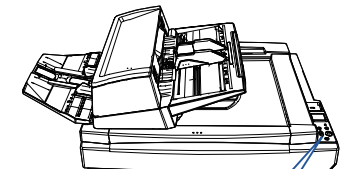
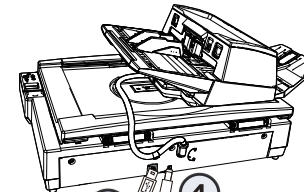
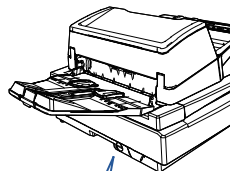

ON

5

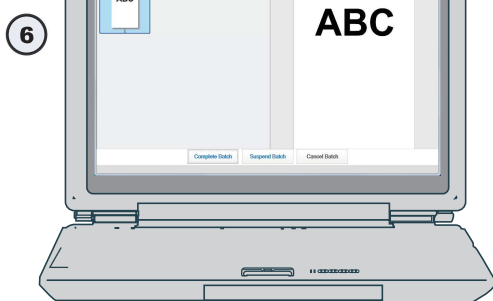
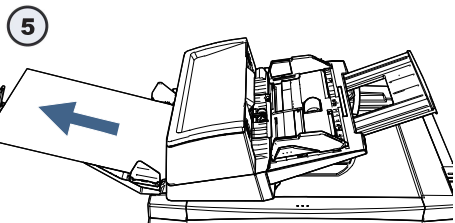
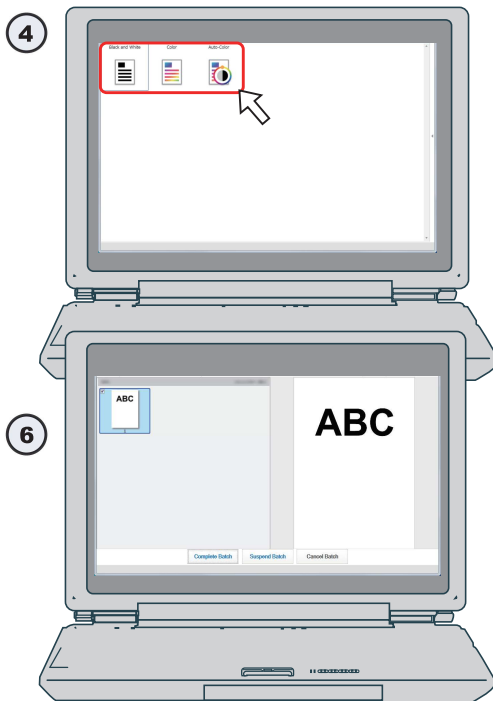
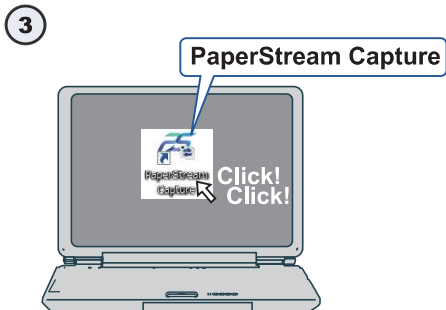
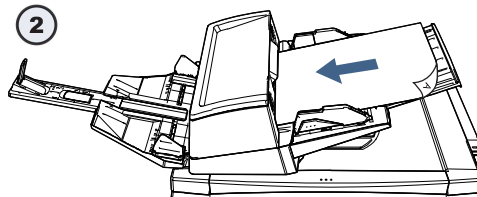
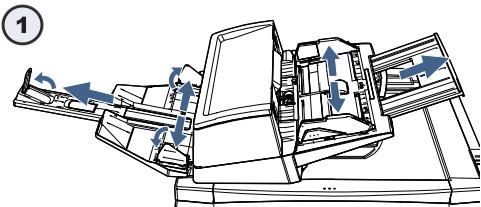

Více informací naleznete v manuálu skeneru, který se nachází na instalačním DVD.

Uchovejte si tento disk na bezpečném místě, jeho opětovné vydání není možné.

Instalační DVD-ROM



Model P3740A/P3740C/P3740E

FUJITSU

Declaration of Conformity

Responsible Party: FUJITSU COMPUTER PRODUCTS OF AMERICA, INC.
Address: 1250 EAST ARQUES AVENUE,
SUNNYVALE, CA 94085-5401, U. S. A.
Phone Number: (408) 746-7000
Fax Number: (408) 746-6910

Hereby declares that the product

Product Name: Image Scanner
P3740A , P3740C
Revision: A0 ~

Conforms to the following specifications:

FCC Part 15, Subpart B, Class B Digital Device

Supplementary Information:

This device complies with part 15 of the FCC Rules. Operation is subject to the following two conditions: (1) this device may not cause harmful interference, and (2) this device must accept any interference received, including interference that may cause undesired operation.

Responsible Person

Name: Masanori Shibusawa
Title: S.V.P. Product Management, Sales
Imaging Products Group

Signature: _____

Date: _____

01/04/2017